

UzS 300-2

2V 300AH

OPzS - UzS

Ultracell®

'Quality in Every Language'

Image

AWAITING
IMAGE

Terminal Type

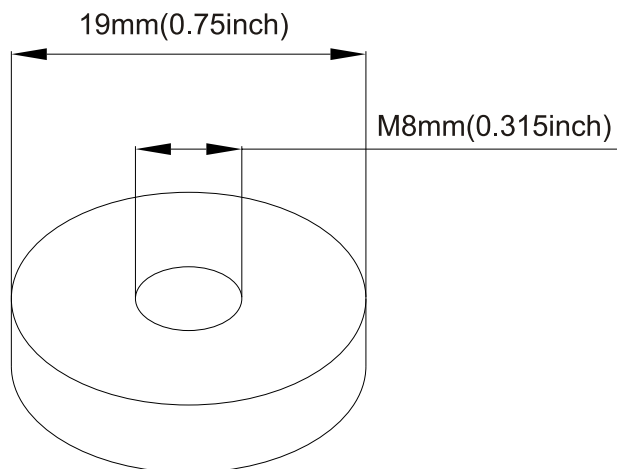

Dimensions

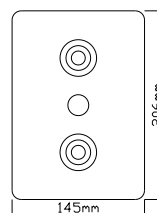
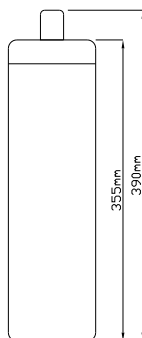

Specifications

Battery Model	UzS 300-2			
Capacity (25°C)	10HR (1.80V)	5HR (1.77V)	3HR (1.75V)	1HR (1.67V)
	300AH	258AH	225AH	159AH
Dimensions	Length	Width	Height	Total Height
	206mm	145mm	355mm	390mm
Approx. Weight	Approx. (with electrolyte) 25.0Kg ~ Approx. (without electrolyte) 19.0Kg			
Self Discharge	3% of capacity declined per month at 20°C			
Capacity Affected by Temperature	40°C	25°C	0°C	-15°C
	102%	100%	85%	65%

Construction

Component ——— Raw material
 Positive ——— Lead dioxide
 Negative ——— Lead
 Container ——— ABS (Flame Retardent optional)
 Cover ——— ABS (Flame Retardent optional)

Sealed and maintenance free option

Sealant ——— Epoxy Resin
 Safety Valve ——— Rubber
 Terminal ——— Copper
 Separator ——— AGM or PVC-SiO₂
 Electrolyte ——— Sulphuric acid and SiO₂ colloid

Non-spillable construction design



CE 1188



MH 29410

Tel | +44 (0) 151 523 2777
Fax | +44 (0) 151 523 0855
E-mail | info@ultracell.co.uk
Web | www.ultracell.co.uk

UzS 300 - 2

2V 300AH

OPzS - UzS

Ultracell®

'Quality in Every Language'

Cycle Service Life in Relation to Depth of Discharge

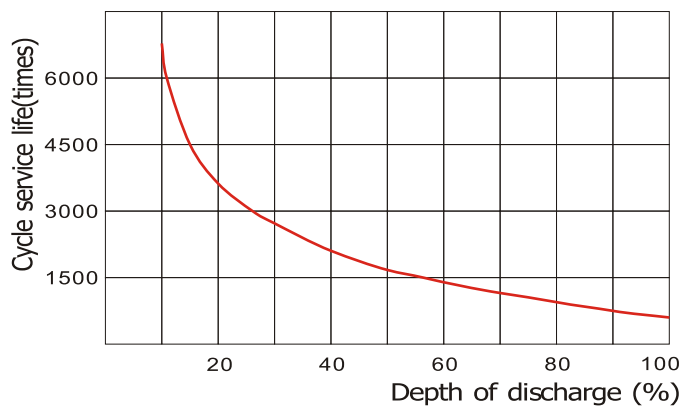

Discharge Characteristic Vs Ambient Temperature Curve

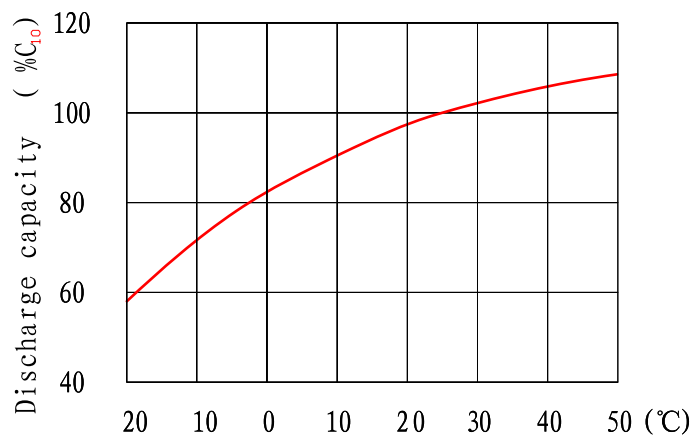

Relation Curves of Service Life and Ambient Temperature

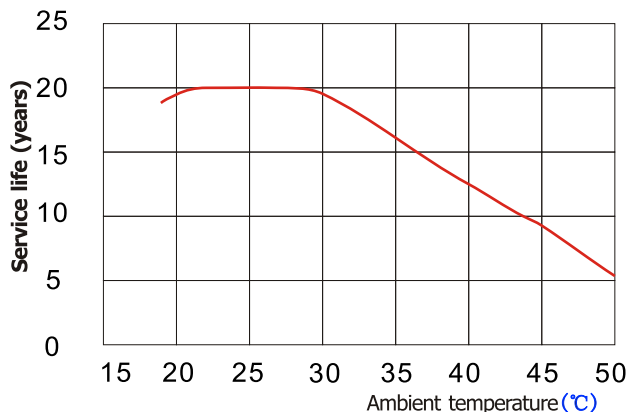

Charge Voltage Vs Ambient Temperature Curve

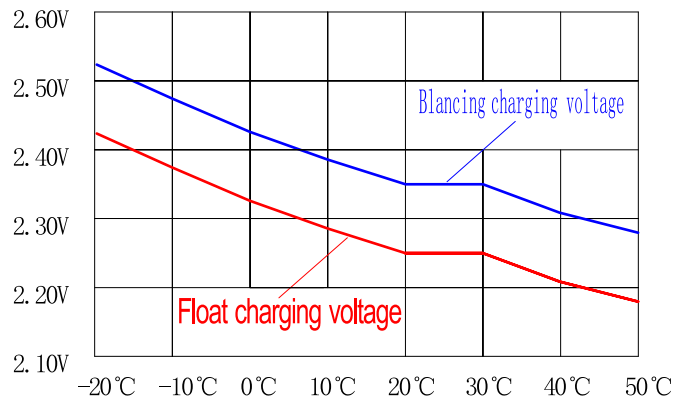

Discharge Characteristics 77°F (25°C)

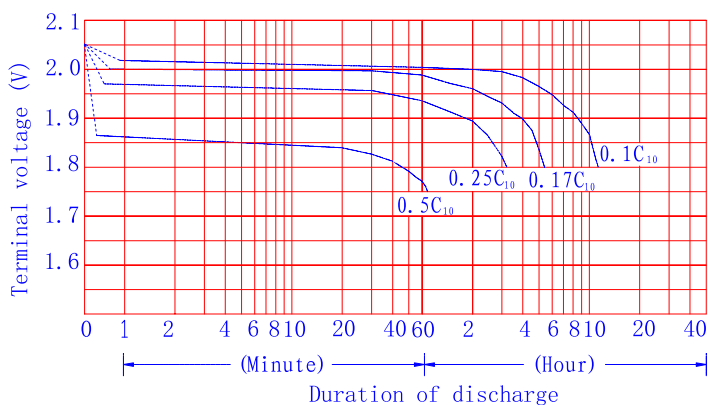

This information is generally descriptive only and is not intended to make or imply any representation, guarantee or warranty with respect to any cells and batteries. Cell and battery designs/specifications are subject to modification without notice.



CE 1188



MH 29410

Tel +44 (0) 151 523 2777
Fax +44 (0) 151 523 0855
E-mail info@ultracell.co.uk
Web www.ultracell.co.uk