

UzV 1500-2

2V 1500AH

OPzV - UzV

Ultracell®

'Quality in Every Language'

Image



Terminal Type

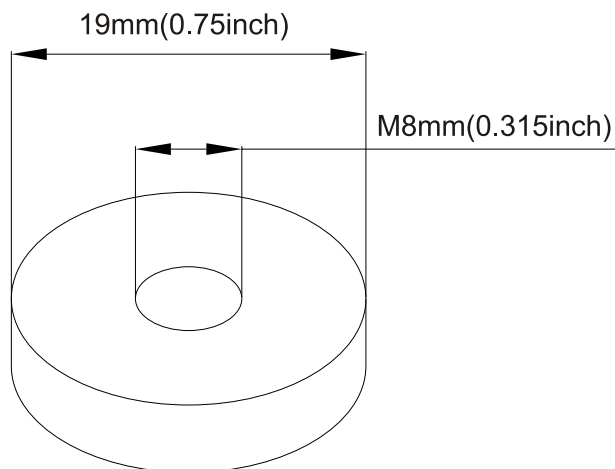

Dimensions

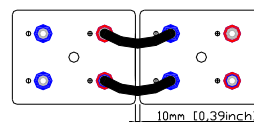
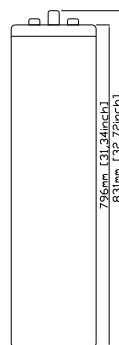
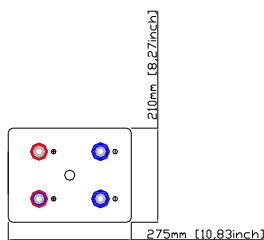

Specifications

| Battery Model | UzV 1500-2 | | | |
|----------------------------------|---|---------------------|-------------------|-------------------|
| Designed Floating Life | > 1200 cycles @ 80% DOD | | | |
| Capacity (25°C) | 10HR (150A, 1.80V) | 5HR (256.4A, 1.77V) | 3HR (372A, 1.75V) | 1HR (744A, 1.67V) |
| | 1500AH | 1280AH | 1116AH | 744AH |
| Dimensions | Length | Width | Height | Total Height |
| | 275mm | 210mm | 796mm | 831mm |
| Approx. Weight | 115Kg +/- 5% | | | |
| Internal Resistance | Fully Charged at 20°C 0.0046 Ohm | | | |
| Self Discharge | 3% of capacity declined per month at 20°C | | | |
| Capacity Affected by Temperature | 40°C | 25°C | 0°C | -15°C |
| | 102% | 100% | 85% | 65% |
| Charge Voltage (25°C) | Cycle Use | | Float Use | |
| | 2.35V (-4mV/°C), max. Current: 375A | | 2.25V (-3mV/°C) | |

Construction

Component ——— Raw material
 Positive ——— Lead dioxide
 Negative ——— Lead
 Container ——— ABS (Flame Retardent optional)
 Cover ——— ABS (Flame Retardent optional)

Sealed and maintenance free option

Sealant ——— Epoxy Resin
 Safety Valve ——— Rubber
 Terminal ——— Copper
 Separator ——— AGM or PVC-SiO₂
 Electrolyte ——— Sulphuric acid and SiO₂ colliod

Non-spillable construction design



CE 1188



MH 29410

Tel | +44 (0) 151 523 2777
 Fax | +44 (0) 151 523 0855
 E-mail | info@ultracell.co.uk
 Web | www.ultracell.co.uk

UzV 1500 - 2

2V 1500AH

OPzV - UzV

Ultracell®

'Quality in Every Language'

Charge Characteristic

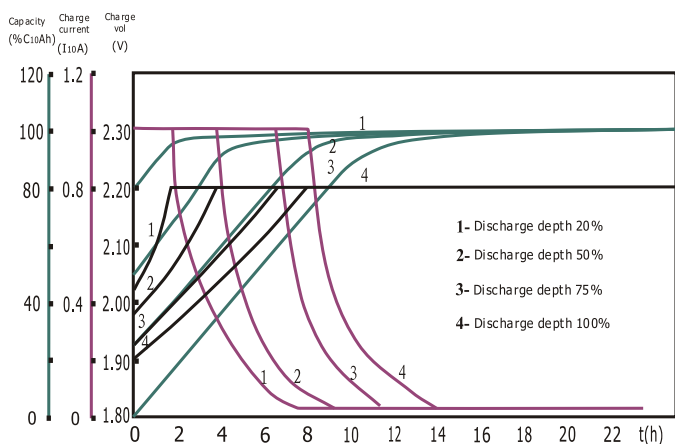

Discharge Characteristic 25°C

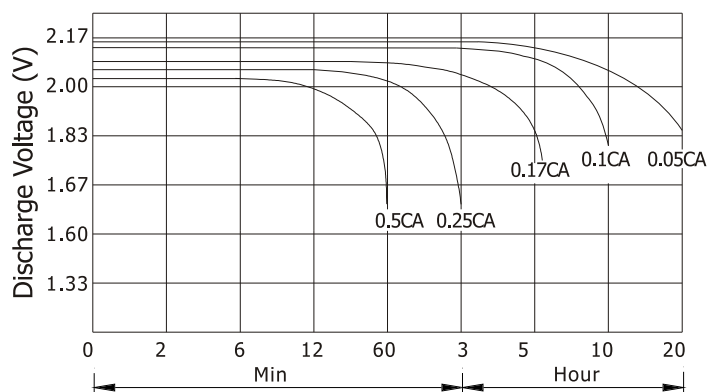

Available Capacity Vs. Ambient Temperature

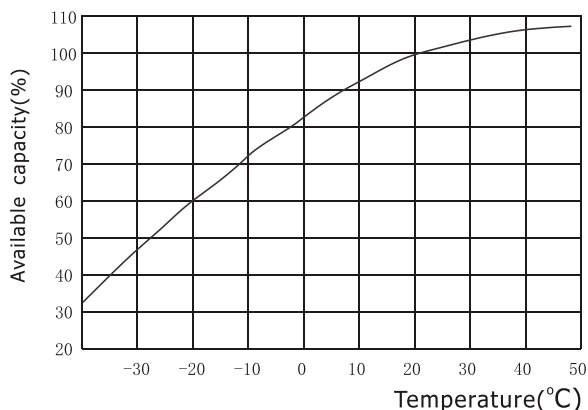

Float Voltage / Equivalent Voltage Vs. Temperature

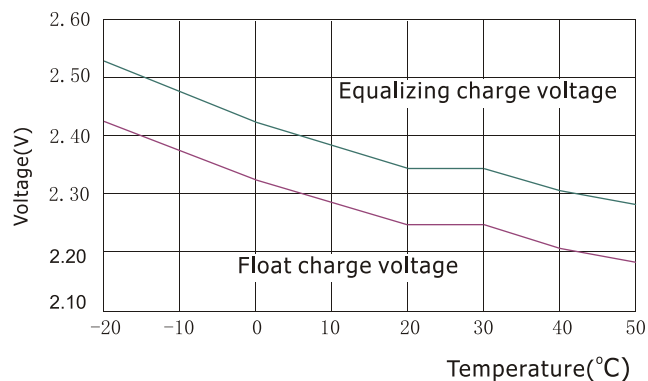

Constant Current Discharge Ratings - amperes at 20°C

| F.V / Time | 5 MIN | 15 MIN | 30 MIN | 1 HR | 2 HR | 3 HR | 4 HR | 5 HR | 10 HR |
|------------|--------|--------|--------|-------|-------|-------|-------|-------|-------|
| 1.60 V | 2625.0 | 2010.0 | 1410.0 | 865.9 | 610.4 | 406.1 | 354.6 | 269.1 | 159.9 |
| 1.65 V | 2525.1 | 1726.5 | 1251.3 | 824.9 | 596.7 | 398.6 | 347.2 | 268.3 | 159.9 |
| 1.70 V | 2337.3 | 1589.9 | 1157.1 | 740.4 | 588.9 | 396.5 | 346.6 | 266.6 | 159.0 |
| 1.75 V | 2187.2 | 1385.8 | 1029.8 | 716.0 | 525.0 | 372.0 | 321.7 | 261.8 | 154.3 |
| 1.80 V | 1920.7 | 1249.8 | 886.2 | 604.5 | 494.2 | 344.8 | 300.0 | 255.0 | 150.0 |
| 1.85 V | 1626.5 | 1043.6 | 691.5 | 469.2 | 453.6 | 305.0 | 270.1 | 239.5 | 143.9 |

Constant Power Discharge Ratings - watts at 20°C

| F.V / Time | 5 MIN | 15 MIN | 30 MIN | 1 HR | 2 HR | 3 HR | 4 HR | 5 HR | 10 HR |
|------------|--------|--------|--------|--------|--------|-------|-------|-------|-------|
| 1.60 V | 4462.5 | 3437.1 | 2425.2 | 1567.2 | 1111.0 | 743.2 | 652.5 | 503.9 | 313.5 |
| 1.65 V | 4368.4 | 3004.1 | 2189.9 | 1509.6 | 1098.0 | 741.4 | 651.5 | 501.7 | 313.3 |
| 1.70 V | 4113.7 | 2814.1 | 2059.7 | 1369.8 | 1095.3 | 737.4 | 645.7 | 500.0 | 311.9 |
| 1.75 V | 3915.1 | 2494.5 | 1864.0 | 1338.9 | 987.0 | 703.1 | 611.3 | 497.9 | 305.4 |
| 1.80 V | 3495.7 | 2287.2 | 1630.7 | 1142.5 | 939.1 | 658.6 | 576.0 | 297.2 | 298.5 |
| 1.85 V | 3057.9 | 1972.4 | 1313.8 | 905.5 | 880.0 | 594.7 | 529.5 | 471.9 | 289.2 |



CE 1188



MH 29410

Tel +44 (0) 151 523 2777
 Fax +44 (0) 151 523 0855
 E-mail info@ultracell.co.uk
 Web www.ultracell.co.uk