

UzV 300-2

2V 300AH

OPzV - UzV

Ultracell®

'Quality in Every Language'

Image



Terminal Type

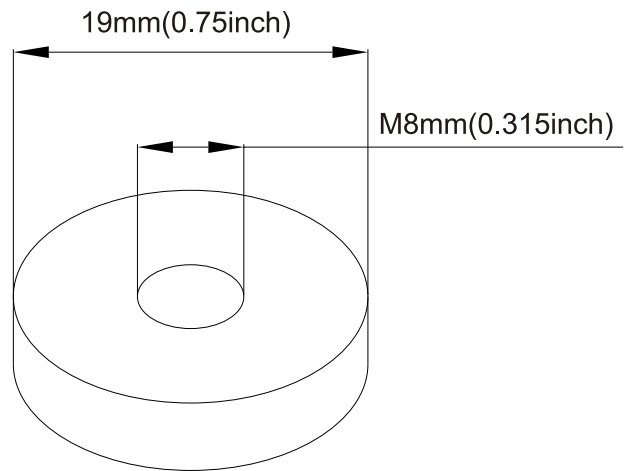

Dimensions

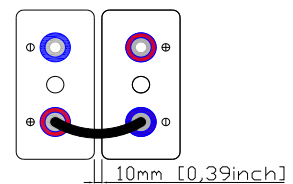
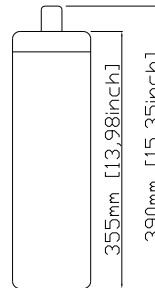
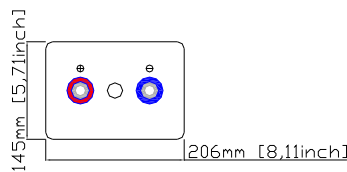
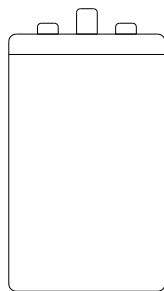

Specifications

Battery Model	UzV 300-2			
Designed Floating Life	> 1200 cycles @ 80% DOD			
Capacity (25°C)	10HR (30A, 1.80V)	5HR (51.6A, 1.77V)	3HR (75A, 1.75V)	1HR (159A, 1.67V)
	300AH	258AH	225AH	159AH
Dimensions	Length	Width	Height	Total Height
	206mm	145mm	355mm	390mm
Approx. Weight	27Kg +/- 5%			
Internal Resistance	Fully Charged at 20°C 0.006 Ohm			
Self Discharge	3% of capacity declined per month at 20°C			
Capacity Affected by Temperature	40°C	25°C	0°C	-15°C
	102%	100%	85%	65%
Charge Voltage (25°C)	Cycle Use		Float Use	
	2.35V (-4mV/°C), max. Current: 75A		2.25V (-3mV/°C)	

Construction

Component ——— Raw material
 Positive ——— Lead dioxide
 Negative ——— Lead
 Container ——— ABS (Flame Retardent optional)
 Cover ——— ABS (Flame Retardent optional)

Sealed and maintenance free option

Sealant ——— Epoxy Resin
 Safety Valve ——— Rubber
 Terminal ——— Copper
 Separator ——— AGM or PVC-SiO₂
 Electrolyte ——— Sulphuric acid and SiO₂ colloid

Non-spillable construction design



CE 1188



MH 29410

Tel | +44 (0) 151 523 2777
 Fax | +44 (0) 151 523 0855
 E-mail | info@ultracell.co.uk
 Web | www.ultracell.co.uk

UzV 300 - 2

2V 300AH

OPzV - UzV

Ultracell®

'Quality in Every Language'

Charge Characteristic

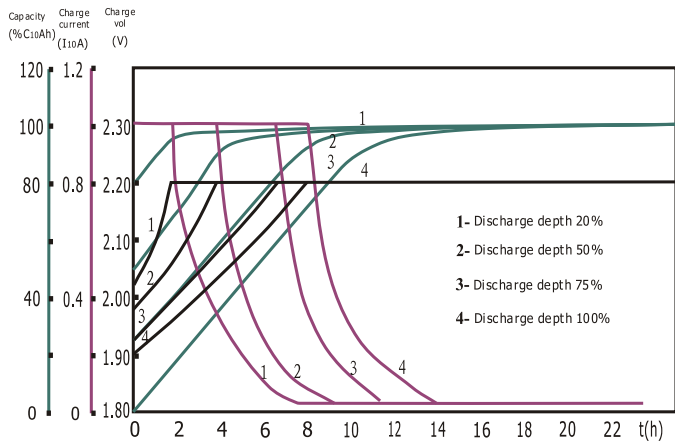

Discharge Characteristic 25°C

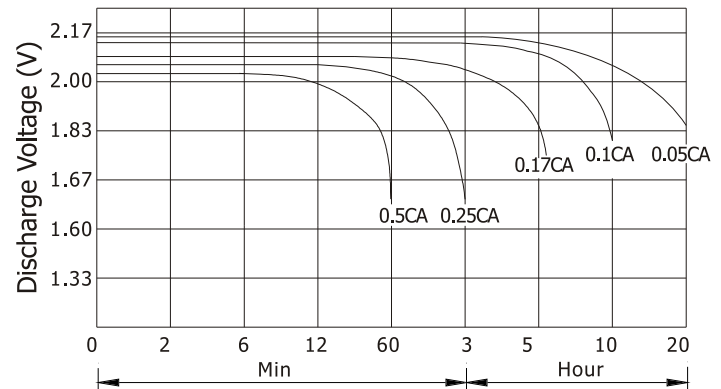

Available Capacity Vs. Ambient Temperature

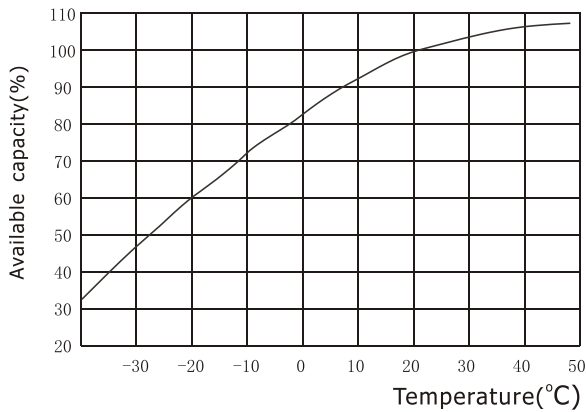

Float Voltage / Equivalent Voltage Vs. Temperature

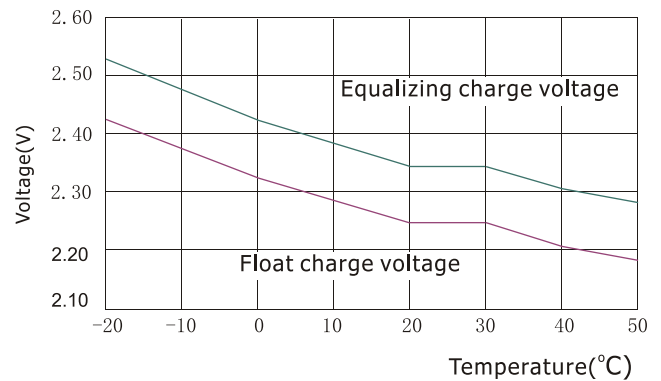

Constant Current Discharge Ratings - amperes at 20°C

F.V / Time	5 MIN	15 MIN	30 MIN	1 HR	2 HR	3 HR	4 HR	5 HR	10 HR
1.60 V	525.0	402.0	282.0	181.4	122.1	81.9	70.9	53.8	32.0
1.65 V	505.0	345.3	250.3	182.8	119.3	80.4	69.4	53.7	32.0
1.70 V	467.5	318.0	231.4	155.1	117.8	79.9	69.3	53.3	31.8
1.75 V	437.4	277.2	206.0	150.0	105.0	75.0	64.3	52.4	20.9
1.80 V	384.1	250.0	177.2	126.6	98.8	69.5	60.0	51.0	30.0
1.85 V	325.3	208.7	138.3	98.3	90.7	61.5	54.0	47.9	28.8

Constant Power Discharge Ratings - watts at 20°C

F.V / Time	5 MIN	15 MIN	30 MIN	1 HR	2 HR	3 HR	4 HR	5 HR	10 HR
1.60 V	892.5	687.4	458.0	328.3	222.2	149.8	130.5	100.8	62.7
1.65 V	873.7	600.8	438.0	316.3	219.6	149.5	130.3	100.3	62.7
1.70 V	822.7	562.8	411.9	287.0	219.1	148.7	129.1	100.0	62.4
1.75 V	783.0	498.9	372.8	280.5	197.4	141.8	122.3	99.6	61.1
1.80 V	699.1	457.4	326.1	239.4	187.8	132.8	115.2	98.4	59.7
1.85 V	611.6	394.5	262.8	189.7	176.0	119.9	105.9	94.4	57.8



Tel +44 (0) 151 523 2777
 Fax +44 (0) 151 523 0855
 E-mail info@ultracell.co.uk
 Web www.ultracell.co.uk